



FURNITUREN | FINDINGS

gold | silver | stainless steel

www.rohde-schmuck.com



ROHDE SCHMUCKWAREN GMBH

Daimlerstraße 20
71299 Wimsheim / GERMANY

Geschäftsführer/-in:
Uwe Rohde
Annette Wiedermann
Registergericht Mannheim HRB 511353
Umsatzsteuer-Ident.-Nr. DE144565226

Tel.: 07044 9426-0
Fax: 07044 9426-26
info@rohde-schmuck.com
www.rohde-schmuck.com



SEIT 1946

»Wir sind immer offen für neue Wege«

»We are always open to new opportunities and ideas«

Uwe Rohde

Rohde stellt Halbfabrikate für die verarbeitende Schmuckindustrie und den Großhandelsbereich her. Zusammen mit dem Tochterunternehmen LG Findings GmbH beschäftigt das Familienunternehmen Rohde Schmuckwaren GmbH rund 40 Mitarbeiter und hat Ihren Sitz in Wimsheim / Germany.

Zum Standard Sortiment gehören unter anderem Bayonettverschlüsse, Brisuren, Ohrstecker, Muttern, Endkappen, Lederketten- und Armbänder, Stahlseile, Goldseile, Wechselschließen und vieles mehr. Das dient nur als Einblick in das faszinierende und umfangreiche Sortiment der Firma.

Rohde produziert und entwickelt Schmuck und Accessoires für viele regionale und internationale Kunden nach kundeneigenem Design (OEM - Original Equipment Manufacturer) und zählt durch die langjährige Erfahrung zu den führenden Herstellern in Deutschland.

Bereits zu erkennen ist hier die Vielfalt und Flexibilität unseres Traditionsunternehmens.

Die Innovationen gelten dem Kundenwunsch und den Ansprüchen von morgen, um neue Schmuckwege für alle gängigen Edelmetalle, Unecht-Legierungen und Kombinationen mit Trendwerkstoffen zu realisieren. Unsere jahrzehntelange Erfahrung in der Schmuckproduktion und im Schmuckgroßhandel setzen wir gezielt ein.

Gerne teilen wir den Erfolg mit unseren Kunden.

Jede Schmuckidee ist es wert, in der Umsetzbarkeit, in der Serienproduktion und der Vermarktung überdacht zu werden.

Rohde manufactures semi-finished products for the jewellery manufacturing industry and for wholesale distribution.

Rohde Schmuckwaren GmbH is a family owned and operated business. Together with our subsidiary, LG Findings GmbH, we have approximately 40 employees.

The company is headquartered in Wimsheim, Germany.

Our standard product range includes items such as bayonet clasps, ear clips, earstuds, earnuts, endcaps, leather chains, as well as wristbands, steel wiring, gold wiring, interchangeable clasps and a lot more.

This should give you a little insight into our company's fascinating and comprehensive product line.

Rohde produces and develops customised jewellery and accessories for local and international customers (OEM – Original Equipment Manufacturer) and, because of our wealth of experience, we are considered one of the leading manufacturers in Germany. Here you can see the diversity and the flexibility of our tradition-rich company.

Our innovation is geared towards customer demand and the requirements of tomorrow. That means new ways of manufacturing jewellery for all common precious metals, artificial alloys and combinations that use modern materials. We apply decades of experience to both jewellery manufacturing and wholesale distribution. We share our success with our customers.

When creative jewellery ideas arise, we consider their feasibility, volume production and marketing.

Alle Angaben ohne Gewähr. Änderungen vorbehalten. Abbildungen und Fotos entsprechen nicht exakt der Originalgröße. Technische sowie Farbänderungen vorbehalten. Alle Artikel sind in verschiedenen Legierungen erhältlich. Es gelten unsere Allgemeinen Geschäftsbedingungen.

All statements without guarantee. Subject to change. Illustrations and photos do not exactly correspond to the original size. Technical and color changes reserved. All articles are available in different alloys. Our general terms and conditions apply.



SCHÜSSELSTECKER

ear stud with cup

Schüssel glatt, Stift 0,88 Ø L: 10mm / cup plain, Pin 0,88 Ø L: 10mm

						
5-1182G 2,5 mm	5-1183G 3 mm	5-1184G 4 mm	5-1185G 5 mm	5-1186G 6 mm	5-1187G 7 mm	5-1188G 8 mm

Schüssel gerieft, Stift 0,88 Ø L: 10mm / cup corrugated, Pin 0,88 Ø L: 10mm

						
5-11825 2,5 mm	5-11830 3 mm	5-11840 4 mm	5-11850 5 mm	5-11860 6 mm	5-11870 7 mm	5-11880 8 mm

PLATTENSTECKER

ear stud with plate

Platte glatt, Stift 0,88 Ø L: 10mm / plate plain, Pin 0,88 Ø L: 10mm

						
5-11930 3 mm	5-11940 4 mm	5-11950 5 mm	5-11960 6 mm	5-11980 8 mm	5-11910 10 mm	5-11912 12 mm

OHRSTECKER

ear stud

mit Stift 0,88 Ø L: 10mm / with Pin 0,88 Ø L: 10mm

						
5-0110S Lilie / Öse längs offen	5-0111S Lilie / Öse quer	5-0111S-030 Lilie / Öse quer 3mm Schüssel gerieft	5-0111S-040 Lilie / Öse quer 4mm Schüssel gerieft	5-0114S Tropfen / Öse quer	5-0114S-030 Tropfen / Öse quer 3mm Schüssel gerieft	5-0114S-040 Tropfen / Öse quer 4mm Schüssel gerieft

KUGELSTECKER

ear stud with ball

Stift 0,88 Ø L: 10mm / Pin 0,88 Ø L: 10mm



							
5-15225 2,5 mm	5-15230 3 mm	5-15235 3,5 mm	5-15240 4 mm	5-15250 5 mm	5-15260 6 mm	5-15270 7 mm	5-15280 8 mm

mit Öse 3,2 mm offen Ø, Stift 0,88 Ø L: 10mm / with loop 3,2 mm Ø, Pin 0,88 Ø L: 10mm

						
5-15325 2,5 mm	5-15330 3 mm	5-15340 4 mm	5-15350 5 mm	5-15360 6 mm	5-15370 7 mm	5-15380 8 mm

OHRMÜTTERN

earnuts

						
5-00037 4 mm leicht	5-00031 4,5 mm weit gerollt	5-00030 5 mm Standard	5-00040 5 mm	5-00034 5 mm mit Zacken	5-00043 6 mm	5-00033 6 mm mit well. Platte

	
5-00039 8 mm mit gelöteter Platte	5-00038 9,2 mm schwer

SILIKONTEILE

silicone parts

						
5-00046 10,5 mm Silikon	5-00044 11,5 mm Silikon/ Silber	5-00045 12,5 mm Silikon / Messing	5-13700 9,5 mm Silikonschutz für Ohrclip	5-13701 9,5 mm Silikonschutz für Ohrclip	5-13702 3 x 3 mm Silikonschutz für Haken	9-00062 10 mm

Alle Angaben ohne Gewähr. Änderungen vorbehalten. Abbildungen und Fotos entsprechen nicht exakt der Originalgröße. Technische sowie Farbänderungen vorbehalten. Alle Artikel sind in verschiedenen Legierungen erhältlich. Es gelten unsere Allgemeinen Geschäftsbedingungen.

All statements without guarantee. Subject to change. Illustrations and photos do not exactly correspond to the original size. Technical and color changes reserved. All articles are available in different alloys. Our general terms and conditions apply.



STIFTE

pins

5-00133-913 L: 7 mm, 1 Rille Ø 1 mm	5-00130-913 L: 10 mm, 1 Rille Ø 0,88 mm, oder 1 mm	5-00129-913 L: 13 mm, 1 Rillen Ø 0,88 mm, oder 1 mm	5-00130-914 L: 10 mm, 2 Rillen Ø 0,88 mm, oder 1 mm	5-00131-914 L: 12 mm, 2 Rillen Ø 0,88 mm, oder 1 mm	5-00134-914 L: 14 mm, 2 Rillen Ø 1 mm	5-00135-914 L: 15 mm, 2 Rillen Ø 1 mm
5-00136-914 L: 16 mm, 2 Rillen Ø 1 mm	5-00140-913 L: 17 mm, 1 Rille Ø 0,88 mm	5-00132-914 L: 12,5 mm, 2 Rillen Ø 0,88 mm, angedreht	5-00139-914 L: 14 mm, 2 Rillen Ø 1 mm, angedreht	5-00137-914 L: 18 mm, 2 Rillen Ø 1 mm, angedreht	5-00138-914 L: 15,5 mm, 2 Rillen Ø 0,88 mm, angedreht	

BRISUREN

lever backs

5-01351 21 mm Bügel	5-01020-909 gebogen	5-01020-910 gerade	7-01030	5-01181-909 gebogen	5-01181-910 gerade
5-01010	5-01010-917 nicht angedrückt unfinished	5-0111V-240 24 mm Bügel Lilie / Öse quer Vorderverschluss	5-01130	5-01090	
5-01133-920 3 mm Schlüssel, gerieft	5-01134-920 4 mm Schlüssel, gerieft	5-01135-920 5 mm Schlüssel, gerieft	5-01136-920 6 mm Schlüssel, gerieft		



BRISUREN

lever backs

Ausführung in glatt erhältlich
available with plain pearl cup

						
5-01173 3 mm Schüssel gerieft	5-01174 4 mm Schüssel gerieft	5-01175 5 mm Schüssel gerieft	5-01176 6 mm Schüssel gerieft	5-01177 7 mm Schüssel gerieft	5-01178 8 mm Schüssel gerieft	5-01171 10 mm Schüssel gerieft

	
5-01174-GGÖ 4mm Schüssel glatt Gewindestift 1 mm Öse quer	5-01174Ö-040 4mm Schüssel gerieft Öse längs

						
5-01193 3 mm Platte	5-01194 4 mm Platte	5-01195 5 mm Platte	5-01196 6 mm Platte	5-01197 7 mm Platte	5-01198 8 mm Platte	5-01191 10 mm Platte

		
5-0119S-040 4 mm Platte, Perlstift gerieft	5-0119S-060 6 mm Platte, Perlstift gerieft	5-0119S-080 8 mm Platte, Perlstift gerieft



Alle Angaben ohne Gewähr. Änderungen vorbehalten. Abbildungen und Fotos entsprechen nicht exakt der Originalgröße. Technische sowie Farbänderungen vorbehalten. Alle Artikel sind in verschiedenen Legierungen erhältlich. Es gelten unsere Allgemeinen Geschäftsbedingungen.

All statements without guarantee. Subject to change. Illustrations and photos do not exactly correspond to the original size. Technical and color changes reserved. All articles are available in different alloys. Our general terms and conditions apply.



5-01100 Lilie / Öse längs	5-01110 Lilie / Öse quer	5-01120 Tropfen / Öse längs	5-01123 Tropfen / Öse längs 3 mm Schüssel gerieft	5-01124 Tropfen / Öse längs 4 mm Schüssel gerieft	5-01125 Tropfen / Öse längs 5 mm Schüssel gerieft	5-01126 Tropfen / Öse längs 6 mm Schüssel gerieft

5-01140 Tropfen / Öse quer	5-01143 Tropfen / Öse quer 3 mm Schüssel gerieft	5-01160 Öse quer	5-01131 3 mm Kugel / Öse längs	5-0112T Tropfen / Öse längs Tulpe

OHRCLIP
earclip

Ausführung in glatt erhältlich
available with plain pearl cup

5-13640 4 mm Schüssel gerieft	5-13650 5 mm Schüssel gerieft	5-13660 6 mm Schüssel gerieft	5-13670 7 mm Schüssel gerieft	5-13680 8 mm Schüssel gerieft	5-13610 10 mm Schüssel gerieft

5-13642-918 4 mm Schüssel gerieft, Öse offen 3,2 mm	5-13652-918 5 mm Schüssel gerieft, Öse offen 3,2 mm	5-13662-918 6 mm Schüssel gerieft, Öse offen 3,2 mm	5-13672-918 7 mm Schüssel gerieft Öse offen 3,2 mm	5-13682-918 8 mm Schüssel gerieft Öse offen 3,2 mm	5-13612-918 10 mm Schüssel gerieft Öse offen 3,2 mm

5-13530 3 mm Kugel	5-13540 4 mm Kugel	5-13550 5 mm Kugel	5-13560 6 mm Kugel	5-13570 7 mm Kugel

5-13532 3 mm Kugel Öse offen 3,2 mm	5-13542 4 mm Kugel Öse offen 3,2 mm	5-13552 5 mm Kugel Öse offen 3,2 mm	5-13562 6 mm Kugel Öse offen 3,2 mm	5-13572 7 mm Kugel Öse offen 3,2 mm	5-13511 Öse offen 3,2 mm Lilie

OHRCLIP | EINZELTEILE

earclip | parts



5-1340F



5-1340B



5-1370F



5-1370B



5-1390F



5-1390B

OHRCLIP

earclip



5-13461
6 mm

5-13481
8 mm

5-13411
10 mm



5-13462
6 mm, Öse zu

5-13482
8 mm, Öse zu

5-13412
10 mm, Öse zu



5-13981
8 mm



5-13991
9 mm



5-13911
10 mm



5-13921
12 mm



5-13950
5 mm
Schüssel gerieft



5-13960
6 mm
Schüssel gerieft



5-13970
7 mm
Schüssel gerieft



5-13980
8 mm
Schüssel gerieft

OHRSCHRAUBEN

screwback - earring

5-01230 Lilie / Öse offen	5-01253 3 mm Kugel	5-01273 3 mm Kugel Öse offen	5-01243 3 mm Schüssel gerieft	5-01244 4 mm Schüssel gerieft	5-01245 5 mm Schüssel gerieft	5-01260

Alle Angaben ohne Gewähr. Änderungen vorbehalten. Abbildungen und Fotos entsprechen nicht exakt der Originalgröße. Technische sowie Farbänderungen vorbehalten. Alle Artikel sind in verschiedenen Legierungen erhältlich. Es gelten unsere Allgemeinen Geschäftsbedingungen.

All statements without guarantee. Subject to change. Illustrations and photos do not exactly correspond to the original size. Technical and color changes reserved. All articles are available in different alloys. Our general terms and conditions apply.



OHRHAKEN

earwire

5-00300 Draht: 0,8 mm	5-00301 Draht: 0,7 mm	5-00303 Draht: 0,80 mm	5-00302 mit Öse und Feder Draht: 0,7 mm	5-00304 mit Öse, Feder und Kugel Draht: 0,7 mm	5-00315 gebogen Draht: 0,7 mm	5-00316 gebogen Draht: 0,88 mm
5-00309-030 3 mm Platte Draht: 0,88 mm	5-00309-040 4 mm Platte Draht: 0,88 mm	5-00309-050 5 mm Platte Draht: 0,88 mm	5-00309-060 6 mm Platte Draht: 0,88 mm	5-00309-080 8 mm Platte Draht: 0,88 mm	5-00309-100 10 mm Platte Draht: 0,88 mm	
5-00306-030 3 mm Schüssel glatt Draht: 0,88 mm	5-00306-040 4 mm Schüssel glatt Draht: 0,88 mm	5-00306-050 5 mm Schüssel glatt Draht: 0,88 mm	5-00306-060 6 mm Schüssel glatt Draht: 0,88 mm	5-00306-070 7 mm Schüssel glatt Draht: 0,88 mm	5-00306-080 8 mm Schüssel glatt Draht: 0,88 mm	
5-00307-030 3 mm Schüssel gerieft Draht: 0,88 mm	5-00307-040 4 mm Schüssel gerieft Draht: 0,88 mm	5-00307-050 5 mm Schüssel gerieft Draht: 0,88 mm	5-00307-060 6 mm Schüssel gerieft Draht: 0,88 mm	5-00307-070 7 mm Schüssel gerieft Draht: 0,88 mm	5-00307-080 8 mm Schüssel gerieft Draht: 0,88 mm	
5-00313-030 3 mm Schüssel gerieft Draht: 0,80 mm	5-00313-040 4 mm Schüssel gerieft Draht: 0,80 mm	5-00313-050 5 mm Schüssel gerieft Draht: 0,80 mm	5-00313-060 6 mm Schüssel gerieft Draht: 0,80 mm	5-00313-070 7 mm Schüssel gerieft Draht: 0,80 mm	5-00313-080 8 mm Schüssel gerieft Draht: 0,80 mm	
5-00310-030 3 mm Schüssel glatt Draht: 0,80 mm	5-00310-040 4 mm Schüssel glatt Draht: 0,80 mm	5-00310-050 5 mm Schüssel glatt Draht: 0,80 mm	5-00310-060 6 mm Schüssel glatt Draht: 0,80 mm			

SCHLAUFEN

bails

				
5-23630 6,5 mm	5-23620 7,5 mm	5-23610 11 mm	5-23650 6,5 mm gewölbt	5-23683 6,5 mm

					
5-23660 8 mm glatt	5-23661 8 mm gerieft	5-23670 10 mm glatt	5-23671 10 mm gerieft	5-23690 11 mm	5-23680 15 mm mit eingewölbter Öse

Perlstift 0,70 mm

			
5-23621 3 mm Schlüsselanhänger gerieft , 3,2 mm Öse	5-23622 4 mm Schlüsselanhänger gerieft , 3,2 mm Öse	5-23623 5 mm Schlüsselanhänger gerieft , 3,2 mm Öse	5-23624 6 mm Schlüsselanhänger gerieft , 3,2 mm Öse

Gewindestift 1,0 mm

						
5-23620-3GG 3 mm Schlüsselanhänger glatt , Öse: 3,2 mm	5-23620-4GG 4 mm Schlüsselanhänger glatt , Öse: 3,2 mm	5-23620-5GG 5 mm Schlüsselanhänger glatt , Öse: 3,2 mm	5-23620-55G 5,5 mm Schlüsselanhänger glatt , Öse: 3,2 mm	5-23620-6GG 6 mm Schlüsselanhänger glatt , Öse: 3,2 mm	5-23620-7GG 7 mm Schlüsselanhänger glatt , Öse: 3,2 mm	5-23620-8GG 8 mm Schlüsselanhänger glatt , Öse: 3,2 mm

SCHLAUFEN MIT ANGELÖTETER SCHÜSSEL

bail with soldered cup

				
5-23694-040 4 mm Schlüssel	5-23694-050 5 mm Schlüssel	5-23694-060 6 mm Schlüssel	5-23694-070 7 mm Schlüssel	5-23694-080 8 mm Schlüssel

Alle Angaben ohne Gewähr. Änderungen vorbehalten. Abbildungen und Fotos entsprechen nicht exakt der Originalgröße. Technische sowie Farbänderungen vorbehalten. Alle Artikel sind in verschiedenen Legierungen erhältlich. Es gelten unsere Allgemeinen Geschäftsbedingungen.

All statements without guarantee. Subject to change. Illustrations and photos do not exactly correspond to the original size. Technical and color changes reserved. All articles are available in different alloys. Our general terms and conditions apply.



SCHÜSSELANHÄNGER MIT GEWINDESTIFT

pendant with *threaded pin*

					
5-12012-030 3,0 mm Schüssel glatt Öse: 3,2 mm, Draht: 1 mm	5-12012-040 4,0 mm Schüssel glatt Öse: 3,2 mm, Draht: 1 mm	5-12012-050 5,0 mm Schüssel glatt Öse: 3,2 mm, Draht: 1 mm	85-12012-055 5,5 mm Schüssel glatt Öse: 3,2 mm, Draht: 1 mm	5-12012-060 6,0 mm Schüssel glatt Öse: 3,2 mm, Draht: 1 mm	5-12012-070 7,0 mm Schüssel glatt Öse: 3,2 mm, Draht: 1 mm

KAPSELN RUND | ÖSE ZU

round caps | closed loop

					
5-40125 2,5 mm Öse 4,7 mm zu	5-40130 3,0 mm Öse 4,7 mm zu	5-40135 3,5 mm Öse 4,7 mm zu	5-40140 4,0 mm Öse 4,7 mm zu	5-40145 4,5 mm Öse 4,7 mm zu	5-40150 5,0 mm Öse 4,7 mm zu

		
5-40160 6,0 mm Öse 4,7 mm zu	5-40170 7,0 mm Öse 4,7 mm zu	5-40180 8,0 mm Öse 4,7 mm zu

KAPSELN RUND | ÖSE OFFEN

round caps | open loop

					
5-40025 2,5 mm Öse 3,2 mm offen	5-40030 3,0 mm Öse 3,2 mm offen	5-40035 3,5 mm Öse 3,2 mm offen	5-40040 4,0 mm Öse 3,2 mm offen	5-40045 4,5 mm Öse 3,2 mm offen	5-40050 5,0 mm Öse 3,6 mm offen

		
5-40060 6,0 mm Öse 3,6 mm offen	5-40070 7,0 mm Öse 3,8 mm offen	5-40080 8,0 mm Öse 3,8 mm offen













2-LOCH KUGELN

balls

						
5-45120 2 mm Kugel, Loch: 0,6 mm	5-45125 2,5 mm Kugel, Loch: 0,7 mm	5-45130 3 mm Kugel, Loch: 0,9 mm	5-45135 3,5 mm Kugel, Loch: 0,9 mm	5-45140 4 mm Kugel, Loch: 1 mm	5-45145 4,5 mm Kugel, Loch: 1 mm	5-45150 5 mm Kugel, Loch: 1,2 mm
						
5-45155 5,5 mm Kugel, Loch: 1,2 mm	5-45160 6 mm Kugel, Loch: 1,3 mm	5-45165 6,5 mm Kugel, Loch: 1,3 mm	5-45170 7 mm Kugel, Loch: 1,3 mm	5-45180 8 mm Kugel, Loch: 1,6 mm	5-45190 9 mm Kugel, Loch: 2 mm	5-45110 10 mm Kugel, Loch: 2 mm
						
5-45111 11 mm Kugel, Loch: 2 mm	5-45112 12 mm Kugel, Loch: 2,3 mm	5-45114 14 mm Kugel, Loch: 2,5 mm	5-45116 16 mm Kugel, Loch: 2,8 mm			

RÖHRCHEN (MIT KARABINER)

lobster with tube

					
5-40806-919 ID: 0,6 mm Öse 3,2 mm zu	5-40808-919 ID: 0,8 mm Öse 3,8 mm zu	5-40811-919 ID: 1,1 mm Öse 3,8 mm zu	5-40813-919 ID: 1,3 mm Öse 3,8 mm zu	5-40215 ID: 1,5 mm Öse 3,8 mm	5-40216 ID: 1,6 mm Öse 3,8 mm
					
5-40806-009 ID: 0,6 mm 9 mm Karabiner	5-40808-009 ID: 0,8 mm 9 mm Karabiner	5-40811-009 ID: 1,1 mm 9 mm Karabiner	5-40813-009 ID: 1,3 mm 9 mm Karabiner	5-40215-009 ID: 1,5 mm 9 mm Karabiner	5-40216-009 ID: 1,6 mm 9 mm Karabiner

Alle Angaben ohne Gewähr. Änderungen vorbehalten. Abbildungen und Fotos entsprechen nicht exakt der Originalgröße. Technische sowie Farbänderungen vorbehalten. Alle Artikel sind in verschiedenen Legierungen erhältlich. Es gelten unsere Allgemeinen Geschäftsbedingungen.

All statements without guarantee. Subject to change. Illustrations and photos do not exactly correspond to the original size. Technical and color changes reserved. All articles are available in different alloys. Our general terms and conditions apply.

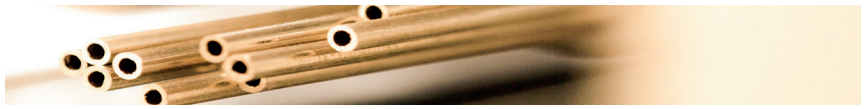

KAPSELN GERADE | ÖSE ZU
caps | closed loop



Art.-Nr. item. no.	ID Ø	Öse loop
5-40218	1,8	3,8mm
5-40219	1,9	
5-40220	2,0	
5-40222	2,2	
5-40224	2,4	
5-40225	2,5	
5-40226	2,6	
5-40228	2,8	
5-40230	3,0	
5-40232	3,2	
5-40235	3,5	
5-40238	3,8	
5-40241	4,1	
5-40245	4,5	
5-40250	5,0	
5-40252	5,2	
5-40254	5,4	
5-40260	6,0	
5-40265	6,5	
5-40272	7,2	
5-40281	8,1	
5-40295	9,5	
5-40210	10,5	5,0mm

KAPSELN RUND MIT ÖSE INNEN + AUSSEN
caps round with loop inside + outside



Art.-Nr. item. no.	ID Ø
5-40308	8 mm; loop inside: 3,2/0,7mm; loop outside: 3,5/1mm
5-40310	10 mm; loop inside: 3,2/0,7mm; loop outside: 3,5/1mm
5-40312	12 mm; loop inside: 3,8/0,8mm; loop outside: 4,5/1,2mm
5-40314	14 mm; loop inside: 3,8/0,8mm; loop outside: 4,5/1,2mm

STERNKAPSELN | ÖSE OFFEN
star caps | open loop























5-40530 3,0 mm Öse 3,2 mm offen	5-40535 3,5 mm Öse 3,2 mm offen	5-40540 4,0 mm Öse 3,2 mm offen	5-40550 5,0 mm Öse 3,6 mm offen

STERNKAPSELN | ÖSE ZU
star caps | closed loop

5-40531 3,0 mm Öse 4,7 mm zu	5-40536 3,5 mm Öse 4,7 mm zu	5-40541 4,0 mm Öse 4,7 mm zu	5-40551 5,0 mm Öse 4,7 mm zu

KAPSELN GERADE MIT KARABINER

lobster with caps

			
5-40218-009 Kapseln gerade ID: 1,8 mm Karabiner 9 mm	5-40219-009 Kapseln gerade ID: 1,9 mm Karabiner 9 mm	5-40220-009 Kapseln gerade ID: 2,0 mm Karabiner 9 mm	5-40222-009 Kapseln gerade ID: 2,2 mm Karabiner 9 mm
			
5-40224-009 Kapseln gerade ID: 2,4 mm Karabiner 9 mm	5-40225-009 Kapseln gerade ID: 2,5 mm Karabiner 9 mm	5-40226-009 Kapseln gerade ID: 2,6 mm Karabiner 9 mm	5-40228-011 Kapseln gerade ID: 2,8 mm Karabiner 11 mm
			
5-40230-011 Kapseln gerade ID: 3,0 mm Karabiner 11 mm	5-40232-011 Kapseln gerade ID: 3,2 mm Karabiner 11 mm	5-40235-011 Kapseln gerade ID: 3,5 mm Karabiner 11 mm	5-40238-011 Kapseln gerade ID: 3,8 mm Karabiner 11 mm
			
5-40241-011 Kapseln gerade ID: 4,1 mm Karabiner 11 mm	5-40245-011 Kapseln gerade ID: 4,5 mm Karabiner 11 mm	5-40250-013 Kapseln gerade ID: 5,0 mm Karabiner 13 mm	5-40252-013 Kapseln gerade ID: 5,2 mm Karabiner 13 mm
			
5-40254-013 Kapseln gerade ID: 5,4 mm Karabiner 13 mm	5-40260-013 Kapseln gerade ID: 6,0 mm Karabiner 13 mm	5-40265-013 Kapseln gerade ID: 6,5 mm Karabiner 13 mm	5-40272-013 Kapseln gerade ID: 7,2 mm Karabiner 13 mm
			
5-40281-016 Kapseln gerade ID: 8,1 mm Karabiner 16 mm	5-40295-016 Kapseln gerade ID: 9,5 mm Karabiner 16 mm	5-40210-016 Kapseln gerade ID: 10 mm Karabiner 16 mm	

SILVER

GOLD

Alle Angaben ohne Gewähr. Änderungen vorbehalten. Abbildungen und Fotos entsprechen nicht exakt der Originalgröße. Technische sowie Farbänderungen vorbehalten. Alle Artikel sind in verschiedenen Legierungen erhältlich. Es gelten unsere Allgemeinen Geschäftsbedingungen.

All statements without guarantee. Subject to change. Illustrations and photos do not exactly correspond to the original size. Technical and color changes reserved. All articles are available in different alloys. Our general terms and conditions apply.









KAPSELN | CNC

CNC caps

					
5-40922 ID: 2,2 mm	5-40929 ID: 2,9 mm	5-40933 ID: 3,3 mm	5-40943 ID: 4,3 mm	5-40953 ID: 5,3 mm	5-40980 ID: 8 mm

KAPSELN CNC MIT KARABINER

lobster with CNC caps

		
5-40922-009 ID: 2,2 mm 9 mm Karabiner	5-40929-011 ID: 2,9 mm 11 mm Karabiner	5-40933-011 ID: 3,3 mm 11 mm Karabiner
		
5-40943-013 ID: 4,3 mm 13 mm Karabiner	5-40953-013 ID: 5,3 mm 13 mm Karabiner	5-40980-016 ID: 8 mm 16 mm Karabiner

STECKVERSCHLUSS

buckle

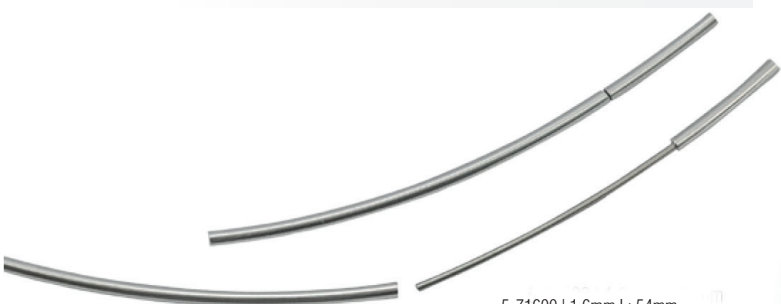

5-71600 | 1,6mm L: 54mm
5-71800 | 1,8mm L: 62mm
5-72000 | 2,0mm L: 62mm

SCHIEBEVERSCHLUSS

slider



9-00048 | 6,8 x 3,6mm, 2-teilig + Feder
9-00044 | 8 x 4,5mm, 2-teilig + Feder

KAPSELN | VIERKANT

square caps

				
5-40633 Kapseln 3 x 3 mm vierkant Öse 5,0 mm zu	5-40644 Kapseln 4 x 4 mm vierkant Öse 5,0 mm zu	5-40642-916 Kapseln 4 x 2 mm rechteckig Öse 5,0 mm quer zu	5-40682-916 Kapseln 8 x 2 mm rechteckig Öse 5,0 mm quer zu	5-40610-916 Kapseln 10 x 2,5 mm rechteckig Öse 5,0 mm quer zu

KAPSELN VIERKANT MIT KARABINER

lobster with square caps

				
5-40633-011 Kapseln 3 x 3 mm Karabiner 11mm	5-40644-011 Kapseln 4 x 4 mm Karabiner 11mm	5-40642-011 Kapseln 4 x 2 mm Karabiner 11mm	5-40682-013 Kapseln 8 x 2 mm Karabiner 13mm	5-40610-013 Kapseln 10 x 2,5 mm Karabiner 13mm

KAPSELN

caps

					
5-40742-916 Guss 4x2 mm Öse quer zu	5-40742-915 Guss 4x2 mm Öse gerade zu	5-40782-916 Guss 8x2 mm Öse quer zu	5-40782-915 Guss 8x2 mm Öse gerade zu	5-40742-011 Guss 4x2 mm Karabiner 11 mm	5-40782-013 Guss 8x2 mm Karabiner 13 mm
					
5-40442-916 4,2x1,8 mm, Öse 3,8 mm quer zu	5-40442-915 4,2x1,8 mm, Öse 3,8 mm längs zu	5-40464-916 6,4x2,3 mm, Öse 3,8 mm quer zu	5-40464-915 6,4x2,3 mm, 3,8 mm Öse längs zu	5-40442-011 4,2x1,8 mm Karabiner 11 mm	5-40464-011 6,4x2,3 mm Karabiner 11 mm

Alle Angaben ohne Gewähr. Änderungen vorbehalten. Abbildungen und Fotos entsprechen nicht exakt der Originalgröße. Technische sowie Farbänderungen vorbehalten. Alle Artikel sind in verschiedenen Legierungen erhältlich. Es gelten unsere Allgemeinen Geschäftsbedingungen.

All statements without guarantee. Subject to change. Illustrations and photos do not exactly correspond to the original size. Technical and color changes reserved. All articles are available in different alloys. Our general terms and conditions apply.



PINS

pins

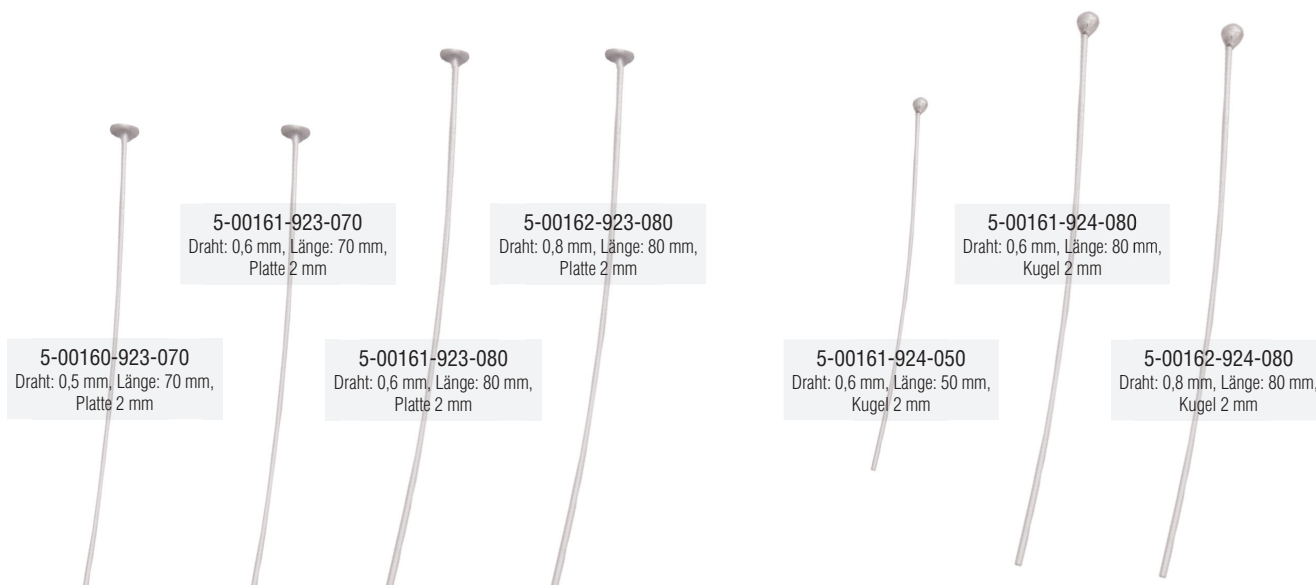

KRAWATTENNADELN

tie pin

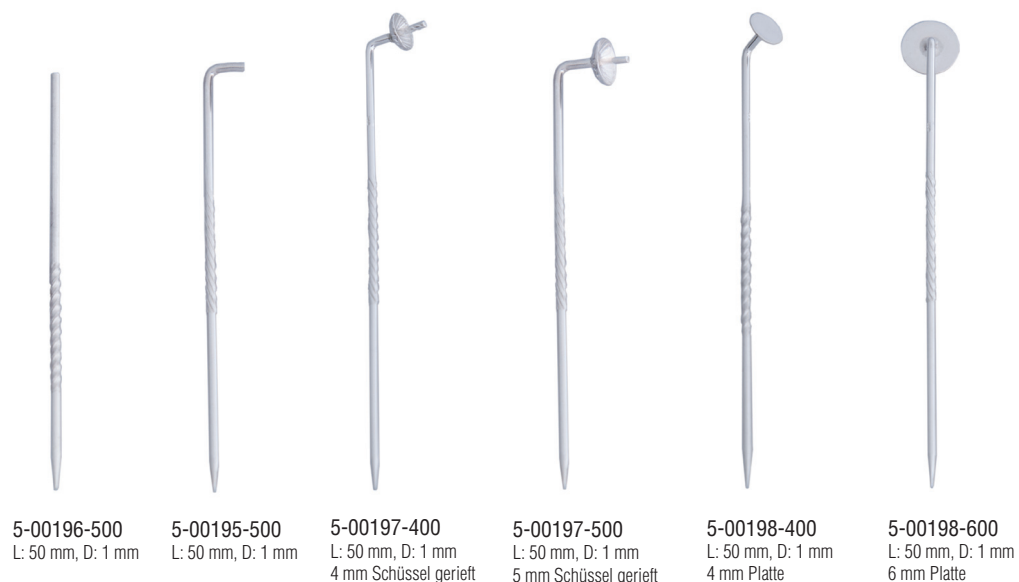

STIFTÖSEN

pins with loop

Stiftösen in offener und geschlossener Ausführung

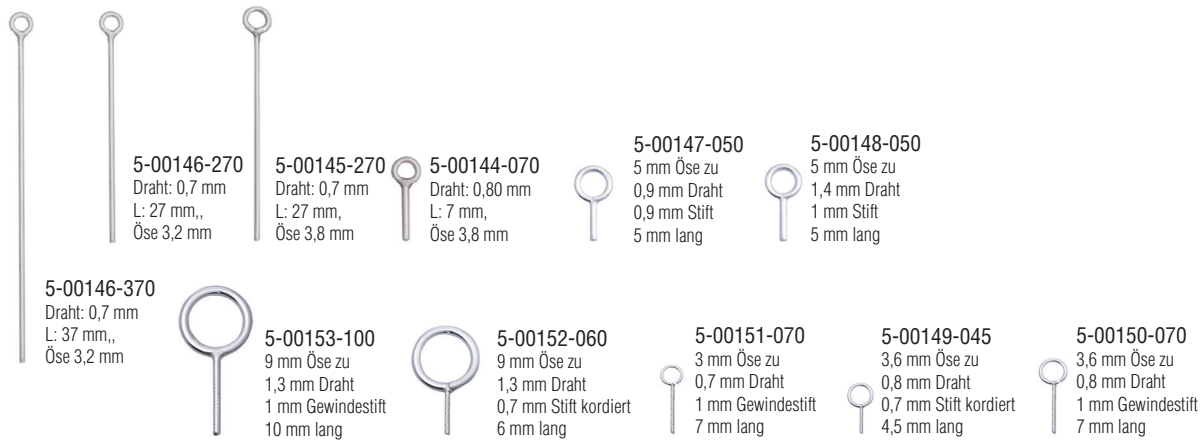

BROSCHIERUNG



BÖCKCHEN

joints

5-00172 Ø 3,0 mm	5-00171 Ø 3,5 mm	5-00173 Ø 3,5 mm	5-00170 Ø 4,0 mm

KUGELSICHERUNG

catches

5-00180-030 Ø 3,0 mm	5-00180-034 Ø 3,4 mm	5-00180-037 Ø 3,7 mm	5-00180-040 Ø 4,0 mm

Alle Angaben ohne Gewähr. Änderungen vorbehalten. Abbildungen und Fotos entsprechen nicht exakt der Originalgröße. Technische sowie Farbänderungen vorbehalten. Alle Artikel sind in verschiedenen Legierungen erhältlich. Es gelten unsere Allgemeinen Geschäftsbedingungen.

All statements without guarantee. Subject to change. Illustrations and photos do not exactly correspond to the original size. Technical and color changes reserved. All articles are available in different alloys. Our general terms and conditions apply.

HAKENNADELN

pinstems

Ausführung: 5-00192, Draht 0,88 mm

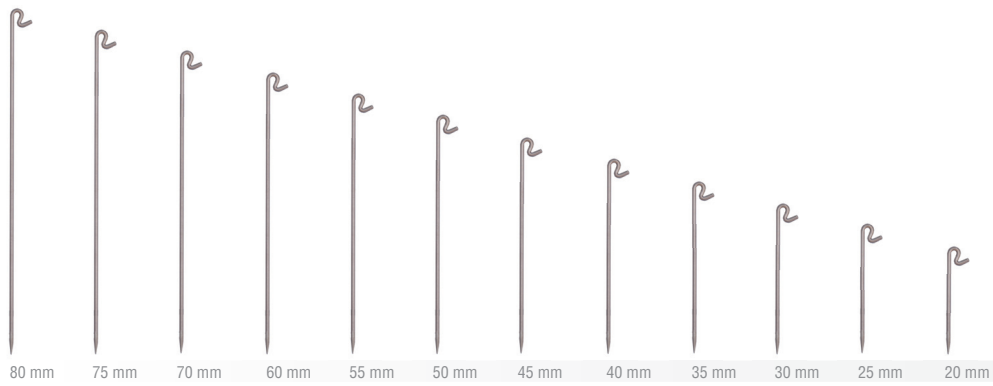

Ausführung: 5-00191, Draht 0,88 mm

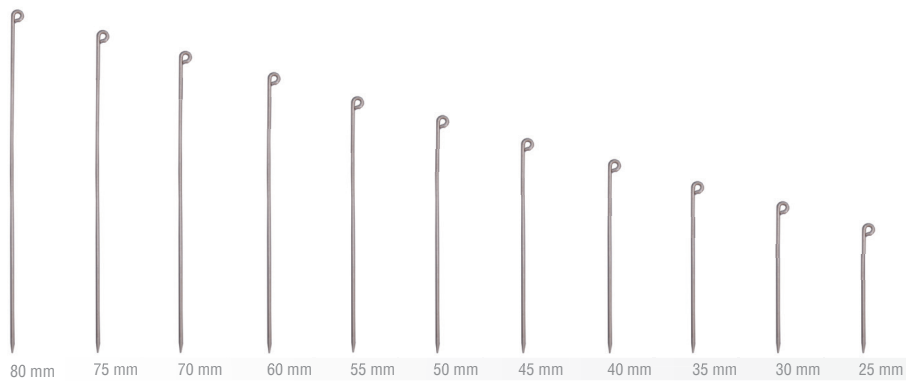

Ausführung: 5-00194, Draht 0,88 mm, mit Querstift



Ausführung: 5-00193, Draht 0,88mm, mit Querstift gepresst



KARABINER | GESTANZT

lobster stamped

				
5-00700-080 8 mm	5-00700-090 9 mm	5-00700-110 11 mm	5-00700-130 13 mm	5-00700-160 16 mm

KARABINER | GEGOSSEN | ÖSE LÄNGS

lobster | casted | loop along







KARABINER | GEGOSSEN | ÖSE QUER

lobster | casted | loop crosswise

			
5-00710-090 9 mm	5-00710-110 11 mm	5-00710-130 13 mm	5-00710-150 15 mm

KARABINER | GEGOSSEN | LEICHTE AUSFÜHRUNG

lobster | casted | light model

			
5-00709-090 9 mm	5-00709-110 11 mm	5-00709-130 13 mm	5-00709-150 15 mm

Alle Angaben ohne Gewähr. Änderungen vorbehalten. Abbildungen und Fotos entsprechen nicht exakt der Originalgröße. Technische sowie Farbänderungen vorbehalten. Alle Artikel sind in verschiedenen Legierungen erhältlich. Es gelten unsere Allgemeinen Geschäftsbedingungen.

All statements without guarantee. Subject to change. Illustrations and photos do not exactly correspond to the original size. Technical and color changes reserved. All articles are available in different alloys. Our general terms and conditions apply.



KARABINER | GEGOSSEN

lobster | casted

5-00714-160 16 x 4,5 mm	5-00714-170 17 x 5 mm	5-00714-220 22 x 6 mm	5-00714-240 24 x 7 mm	5-00714-250 25 x 7,5 mm	5-00714-280 28 x 9 mm	5-00714-270 27 x 10 mm	5-00714-260 26 x 11 mm

KARABINER | GEGOSSEN

lobster | casted

5-00715-090 9 x 4 mm	5-00715-110 11 x 4 mm	5-00715-130 13 x 5 mm

KARABINER | GEGOSSEN | ÖSE LÄNGS

lobster | casted | loop along

5-00711-085 8,5 mm	5-00711-100 10 mm	5-00711-110 11 mm	5-00711-120 12 mm	5-00711-130 13 mm	5-00711-150 15 mm

KARABINER | GEGOSSEN

lobster | casted

5-00713-120 12 mm	5-00713-160 16 mm	5-00713-180 18 mm

KARABINER | HERZ

lobster | heard

5-00716-090 9 mm	5-00716-110 11 mm

LEICHTE AUSFÜHRUNG | NUR IN GOLD
light model | only in gold

FEDERRING | ÖSE LÄNGS

springring | loop along

			
5-00642-045 4,5 mm	5-00642-050 5 mm	5-00642-055 5,5 mm	5-00642-060 6 mm

FEDERRING | ÖSE QUER

springring | loop crosswise

			
5-00640-045 4,5 mm	5-00640-050 5 mm	5-00640-055 5,5 mm	5-00640-060 6 mm

SCHWERE AUSFÜHRUNG
heavy model

FEDERRING | ÖSE LÄNGS

springring | loop along

		
5-00643-050 5 mm	5-00643-055 5,5 mm	5-00643-060 6 mm

FEDERRING | ÖSE QUER

springring | loop crosswise

				
5-00641-050 5 mm	5-00641-055 5,5 mm	5-00641-060 6 mm	5-00641-070 7 mm	5-00641-080 8 mm

WECHSELMECHANIK

interchangeable system

						
5-26325 Schaft: 3,0 mm Bohrung: 2,5 mm	5-26335 Schaft: 3,5 mm Bohrung: 3,0 mm	5-26345 Schaft: 4,5 mm Bohrung: 4,0 mm	5-26355 Schaft: 5,5 mm Bohrung: 5,0 mm	5-26301 Schaft: 2,6 mm Bohrung: 1,5 mm L: 1 mm zum anlöten	5-26300 Schaft: 2,6 mm Bohrung: 1,5 mm L: 1 mm zum Fädeln	5-26401 3,4 x 5 mm mit Rand, montiert

Alle Angaben ohne Gewähr. Änderungen vorbehalten. Abbildungen und Fotos entsprechen nicht exakt der Originalgröße. Technische sowie Farbänderungen vorbehalten. Alle Artikel sind in verschiedenen Legierungen erhältlich. Es gelten unsere Allgemeinen Geschäftsbedingungen.

All statements without guarantee. Subject to change. Illustrations and photos do not exactly correspond to the original size. Technical and color changes reserved. All articles are available in different alloys. Our general terms and conditions apply.



BAYONETTE VERSCHLUSS

bayonette clasp

AD	ID	Länge	Edelstahl	Silber	Gold	Weissgold
1,6 / 0,7 / 15,0			■	■		
1,6 / 0,7 / angespitzt			■	■	■	■
1,6 / 1,15 / 15,0					■	■
1,6 / 1,15 / 16,8			■	■		
1,6 / 1,15 / 20,8			■	■		
1,6 / 1,2 / 14,8						
1,8 / 0,6 / 16,8			■			
1,8 / 0,6 / 19,6				■		
1,8 / 0,8 / 19,6				■		
1,8 / 0,8 / 16,8					■	■
1,8 / 0,9 / 16,8				■	■	
1,8 / 1,1 / 20,0			■			
1,8 / 1,1 / 16,8				■	■	■
1,8 / 1,2 / 20,7			■			
1,8 / 1,3 / 16,8				■	■	■
1,8 / 1,3 / 20,8			■	■		
1,8 / 1,5 / 16,8			■	■	■	■
1,8 / 1,5 / 20,8			■	■		
2,0 / 1,7 / 16,8				■	■	■
2,0 / 1,7 / 20,8			■	■		
2,5 / 1,6 / 18,0			■			
2,5 / 1,6 / 16,8				■		
2,5 / 1,6 / 22,8			■	■		
2,5 / 2,0 / 22,8			■	■		
2,5 / 2,2 / 22,8			■	■		
2,7 / 2,0 / 18,0			■			
2,7 / 2,0 / 17,5				■		
2,7 / 2,0 / 16,8				■		
2,7 / 2,0 / 16,8					■	■
2,7 / 2,0 / 22,8			■	■		
2,7 / 2,0 / 22,8 quergebohrt			■	■		
2,7 / 2,1 / 16,6						
2,7 / 2,2 / 22,8				■		

	Edelstahl	Silber	Gold	Weissgold
3,0 / 2,5 / 16,8			■	■
3,0 / 2,5 / 18,0	■	■		
3,0 / 2,5 / 22,5			■	■
3,0 / 2,5 / 22,8	■	■		
3,2 / 2,7 / 22,5	■			
3,2 / 2,7 / 22,8		■		
3,5 / 2,9 / 22,8	■			
3,5 / 3,0 / 22,8 quergebohrt	■			
3,5 / 3,0 / 16,8 quergebohrt		■		
3,5 / 3,0 / 19,6	■	■		
3,5 / 3,0 / 22,8	■	■		
3,5 / 3,0 / 16,8 mit Loch			■	■
3,5 / 3,0 / 16,8 quergebohrt mit Loch			■	■
3,7 / 3,2 / 22,5 quergebohrt		■		
3,7 / 3,2 / 22,8	■	■		
4,0 / 3,5 / 20,8	■			
4,0 / 3,5 / 26,0	■			
4,0 / 3,5 / 18,6 mit Loch		■		
4,0 / 3,5 / 17,6 mit Loch			■	■
4,5 / 4,0 / 23,6 quergebohrt	■			
4,5 / 4,0 / 22,8 mit Loch	■			
4,5 / 4,0 / 18,5 quergebohrt		■		
4,5 / 4,0 / 17,7 mit Loch				
4,5 / 4,0 / 22,8	■	■		
4,5 / 4,0 / 17,6 mit Loch			■	■
4,7 / 4,2 / 22,8	■			
4,7 / 4,2 / 23,6		■		
5,0 / 4,5 / 27,4	■			

	Edelstahl	Silber	Gold	Weissgold
5,5 / 5,0 / 21,8	■			
5,5 / 5,0 / 25,5	■			
5,5 / 5,0 / 24,5 quergebohrt	■			
5,5 / 5,0 / 26,6 mit Loch		■		
5,5 / 5,0 / 19,6 mit Loch		■		
5,5 / 5,0 / 18,9 mit Loch			■	■
5,8 / 5,3 / 22,8	■			
5,8 / 5,3 / 25,5		■		
6,5 / 6,0 / 26,8	■			
6,5 / 6,0 / 21,7 mit Loch		■		
6,5 / 6,0 / 21,5 mit Loch			■	■
7,0 / 6,5 / 25,9	■			
7,0 / 6,5 / 21,5 mit Loch		■	■	■
8,0 / 7,0 / 28,7	■			
8,0 / 7,0 / 23,8 mit Loch		■		
9,0 / 8,0 / 26,0 mit Loch	■			
9,0 / 8,0 / 24,3 mit Loch		■		
10,0 / 9,0 / 25,8 mit Loch	■	■		
11,0 / 10,0 / 28,6 mit Loch		■		
11,0 / 10,0 / 28,6	■	■		
11,0 / 10,0 / 28,9			■	■
14,0 / 13,0 / 35,6		■		

AD = Außendurchmesser / outer diameter
ID = Innendurchmesser / inner diameter

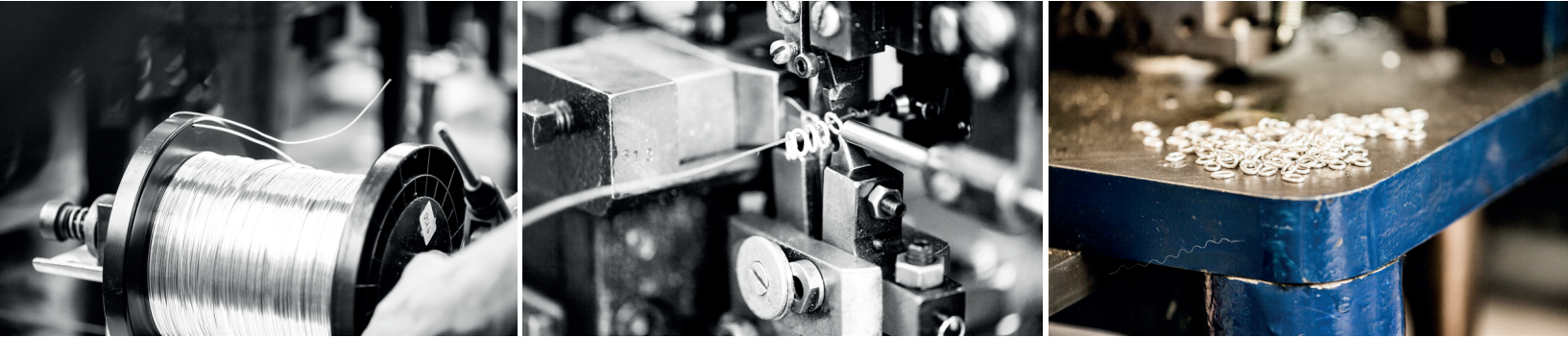

ÖSEN | RUND OFFEN + GESCHLOSSEN

loops round, open and closed



■ Silber + Gold ■ Messing ■ Edelstahl

AD in mm	2,8	3,0	3,2	3,5	3,6	3,8	4,0	4,5	4,7	5,0	5,5	6,0	7,0	8,0	9,0	10,0	12,0	14,0
0,6		■		■														
0,7		■	■	■	■													
0,8		■	■		■	■	■	■	■	■	■							
0,9					■		■	■	■	■	■	■						
1,0							■		■	■		■	■	■		■	■	
1,1									■	■								
1,2												■	■	■			■	
1,3													■		■			
1,4															■	■		
2,0																■	■	■

ÖSEN | OVAL OFFEN + GESCHLOSSEN

loops oval, open and closed

■ Silber + Gold ■ Messing ■ Edelstahl

AD in mm	2,8	3,0	3,2	3,5	3,6	3,8	4,0	4,5	4,7	5,0	5,5	6,0	7,0	8,0	9,0	10,0	12,0	14,0
0,6		■	■															
0,7				■	■													
0,8							■	■	■									
0,9										■	■	■						
1,0												■	■					
1,1													■	■				
1,2														■	■		■	
1,3															■	■		
1,4															■	■		
2,0																■	■	■

SPEZIELLE ÖSEN

5-52001-916 4+6 mm Öse quer	5-52002-916 3,2+4 mm Öse quer	5-52000-000 3 + 4 mm Öse flach	5-51055 5,5 mm oval D: 0,6 mm	5-51054 5,4 x 2,5 mm oval D: 0,88 x 0,33 mm flach zu	5-51042 4,2 x 3,2 mm oval D: 1,15 x 0,65 mm halbrund zu

Alle Angaben ohne Gewähr. Änderungen vorbehalten. Abbildungen und Fotos entsprechen nicht exakt der Originalgröße. Technische sowie Farbänderungen vorbehalten. Alle Artikel sind in verschiedenen Legierungen erhältlich. Es gelten unsere Allgemeinen Geschäftsbedingungen.

All statements without guarantee. Subject to change. Illustrations and photos do not exactly correspond to the original size. Technical and color changes reserved. All articles are available in different alloys. Our general terms and conditions apply.

KNEBELVERSCHLUSS

toggle

			
5-00664 Stab: 15 x 1,5 mm Kugel: 2,7 mm Ring: 5,7 x 1,5 mm	5-00662 Stab: 25 x 2 mm Kugel: 3,1 mm Ring: 10,5 x 2 mm	5-00661 Stab: 35 x 5 mm Ring: 15 x 3 mm	5-00660 Stab: 45 x 5 mm Ring: 21 x 3 mm

KETTENVERBINDER

chain link

				
5-00666-120 12 mm	5-00666-140 14 mm	5-00666-180 18 mm	5-00666-200 20 mm	5-00666-250 25 mm

				
5-00668 22 x 16 mm	5-00667 25 x 18 mm	5-00668-908 22 x 16 mm	5-00667-908 25 x 18 mm	5-00669 27 x 20 mm

KNOPFSICHERUNG

key ring



KRAWATTENHALTER

tie fastening



5-00651
Krawattenhalter 35mm, Draht: 1 mm, Kette 17 cm

5-00650
Krawattenhalter 35mm, Draht: 1 mm

MANSCHETTENKNOPFMECHANIK

cuff links



5-00200
17,6 x 8,5 x 1 mm Platte oval

5-00202

5-00201

SCHLÜSSELRINGE

key ring



5-00653
19,5 x 38 mm

5-00654
19,5 x 38 mm
Kette 3 cm



5-00657-350
AD: 35 mm
Draht: 2,5 mm



5-00657-300
30 mm
Draht: 2,5 mm



5-00655-200
20 mm
Draht: 1,6 mm



5-00656-260
26 mm
Draht: 2,0 mm



5-00656-300
30 mm
Draht: 2,0 mm

STEMPELPLÄTTCHEN

id tag

5-53081 8 x 5 mm, 1 Loch	5-53082 8 x 5 mm, 2 Loch	5-53011 10 x 7 mm, 1 Loch	5-53012 10 x 7 mm, 2 Loch	5-53050 5 mm	5-53001 3,1 x 0,36 mm	5-53000 5 x 3,6 mm	5-53002 7 x 4 mm
5-53045 5 mm, 1 Loch	5-53061 6,6 mm, 1 Loch	5-53010-925 10 mm, 1 Loch	5-53010-926 10 mm, 2 Loch	5-53015-925 15 mm, 1 Loch	5-53020-925 20 mm, 1 Loch	5-53014-926 14,5 x 3 mm, 2 Loch	

Alle Angaben ohne Gewähr. Änderungen vorbehalten. Abbildungen und Fotos entsprechen nicht exakt der Originalgröße. Technische sowie Farbänderungen vorbehalten. Alle Artikel sind in verschiedenen Legierungen erhältlich. Es gelten unsere Allgemeinen Geschäftsbedingungen.















All statements without guarantee. Subject to change. Illustrations and photos do not exactly correspond to the original size. Technical and color changes reserved. All articles are available in different alloys. Our general terms and conditions apply.

high quality

STAINLESS STEEL FINDINGS













KAPSELN | CNC

caps | cnc

							
5-40917 ID: 1,7 mm	5-40922 ID: 2,2 mm	5-40926 ID: 2,6 mm	5-40931 ID: 3,1 mm	5-40933 ID: 3,3 mm	5-40938 ID: 3,8 mm	5-40941 ID: 4,1 mm	5-40943 ID: 4,3 mm
							
5-40951 ID: 5,1 mm	5-40953 ID: 5,3 mm	5-40956 ID: 5,6 mm	5-40966 ID: 6,6 mm	5-40971 ID: 7,1 mm	5-40976 ID: 7,6 mm	5-40980 ID: 8 mm	

CNC KAPSELN MIT KARABINER

cnc caps with lobster

			
5-40926-009 ID: 2,6 mm Karabiner 9 mm	5-40931-011 ID: 3,1 mm Karabiner 11 mm	5-40938-011 ID: 3,8 mm Karabiner 11 mm	5-40941-013 ID: 4,1 mm Karabiner 13 mm
			
5-40943-013 ID: 4,3 mm Karabiner 13 mm	5-40951-013 ID: 5,1 mm Karabiner 13 mm	5-40953-015 ID: 5,3 mm Karabiner 15 mm	5-40956-015 ID: 5,6 mm Karabiner 15 mm
			
5-40966-015 ID: 6,6 mm Karabiner 15 mm	5-40971-015 ID: 7,1 mm Karabiner 15 mm	5-40976-015 ID: 7,6 mm Karabiner 15 mm	5-40980-015 ID: 8,0 mm Karabiner 15 mm

KAPSELN MIT KARABINER

lobster with caps



SCHLOSS MIT ENDKAPPEN

lock with endcaps



KAPSELN MIT KARABINER

lobster with caps

<p>5-49007 ID: 1,7 mm Karabiner 11 mm Öse 5,5 mm beweglich</p>	<p>5-49008 ID: 2,3 mm Karabiner 11 mm Öse 5,5 mm beweglich</p>	<p>5-49004 ID: 2 mm Karabiner 11 mm Öse 5,5 mm beweglich</p>	<p>5-49005 ID: 3 mm Karabiner 11 mm Öse 7,0 mm beweglich</p>	<p>5-49006 ID: 4 mm Karabiner 11 mm Öse 7,5 mm beweglich</p>

STAINLESS STEEL

ENDKAPPEN MIT STIFT FÜR PERLES

endcaps with pin for pearls

<p>9-00026 3 mm</p>	<p>9-00025 4 mm</p>	<p>9-00024 5 mm</p>	<p>9-00027 7,2 mm</p>



Alle Angaben ohne Gewähr. Änderungen vorbehalten. Abbildungen und Fotos entsprechen nicht exakt der Originalgröße. Technische sowie Farbänderungen vorbehalten. Alle Artikel sind in verschiedenen Legierungen erhältlich. Es gelten unsere Allgemeinen Geschäftsbedingungen.

All statements without guarantee. Subject to change. Illustrations and photos do not exactly correspond to the original size. Technical and color changes reserved. All articles are available in different alloys. Our general terms and conditions apply.

KAPSELN

caps

			
5-40660 6 x 2,5 mm 2-teilig	5-40670 7 x 2,5 mm 2-teilig	5-40695 9,5 x 2,5 mm 2-teilig	5-40614 14,5 x 5 mm 2-teilig

VERSCHLUSS

claps

	
5-01511-015 15 mm	5-01500-015 15 mm

KARABINER MIT KAPSELN

lobster with caps

			
5-40660-013 Kapsel 6 x 2,5 mm Karabiner 13 mm	5-40670-013 Kapsel 7 x 2,5 mm Karabiner 13 mm	5-40695-013 Kapsel 9,5 x 2,5 mm Karabiner 13 mm	5-40614-015 Kapsel 14,5 x 5 mm Karabiner 15 mm

KAPSELN MIT KARABINER

lobster with caps

			
5-49003 4 mm Kapseln mit SchlieÙe	5-49002 4 mm Kapseln mit SchlieÙe (mit Pin)	5-49001 5 mm Kapseln mit SchlieÙe	5-49000 5 mm Kapseln mit SchlieÙe (mit Pin)

FEDERRINGE

spring rings

						
5-00641-060 Federring rund 6 mm	5-00641-080 Federring rund 8 mm	5-00641-100 Federring rund 10 mm	5-00641-120 Federring rund 12 mm	5-00641-140 Federring rund 14 mm	5-00641-160 Federring rund 16 mm	5-00641-180 Federring rund 18 mm

KARABINER

lobster

						
5-00700-090 9 mm	5-00700-011 11 mm	5-00700-013 13 mm	5-00700-015 15 mm	5-00700-019 19 mm	5-00700-025 25 mm	5-00700-033 33 mm

			
5-01508-015 15 mm	5-01505-011 11 mm	5-01505-016 16 mm	5-01505-022 22 mm

		
5-01502-020 20 mm	5-01502-025 25 mm	5-01502-032 32 mm

STAINLESS STEEL

	
5-00719-10000-240 24 mm	5-00719-10000-190 19 mm

RINGSCHLIESSE

ring clasps

	
5-00666-180 18 mm	5-00666-200 20 mm

SCHLÜSSELRING

key ring





5-00655-200 20 mm, Draht 1,6mm



Alle Angaben ohne Gewähr. Änderungen vorbehalten. Abbildungen und Fotos entsprechen nicht exakt der Originalgröße. Technische sowie Farbänderungen vorbehalten. Alle Artikel sind in verschiedenen Legierungen erhältlich. Es gelten unsere Allgemeinen Geschäftsbedingungen.



All statements without guarantee. Subject to change. Illustrations and photos do not exactly correspond to the original size. Technical and color changes reserved. All articles are available in different alloys. Our general terms and conditions apply.

MAGNETSCHLIESSE

magnetic clasps

			
5-M0810-000 8 mm	5-M1010 10 mm	5-M1210 12 mm	5-M1410 14 mm

	
5-99907-996 poliert 23 x 16 x 6 mm 5-99907-997 matt 23 x 16 x 6 mm	

	
5-99909 24 x 14 x 7 mm poliert + matt	

	
5-99927 21,5 x 13 x 8 mm	5-99928 19,5 x 13 x 8 mm

	
5-99929-996-120 poliert 12 x 6mm 5-99929-997-120 matt 12 x 6mm	

	
5-99929-996-100 poliert 10 x 5mm 5-99929-997-100 matt 10 x 5mm	



6x12mm ID: 2mm: 5-99922 ID: 2,5mm: 5-99921 ID: 3mm: 5-99932



7x12mm ID: 3,1mm: 5-99915 ID: 3,3mm: 5-99916 ID: 4,1mm: 5-99933

8x14mm ID: 4mm: 5-99914 ID: 4,3mm: 5-99924 ID: 4,6mm: 5-99926 ID: 5mm: 5-99911 ID: 5,3mm: 5-99937

9x16mm ID: 6mm: 5-99920

10x20mm ID: 6,5mm: 5-99917 ID: 7mm: 5-99918

11,5x20mm ID: 8mm: 5-99919







12x14mm ID: 4mm: 5-99913 ID: 4,3mm: 5-99923 ID: 4,6mm: 5-99925 ID: 5mm: 5-99910



polished (996)
mat (997)

MAGNETSCHLIESSE

magnetic clasps

			
7x12mm ID: 3,1mm: 5-99950 ID: 3,3mm: 5-99951 ID: 4,0mm: 5-99960	8x14mm ID: 4mm: 5-99952 ID: 4,3mm: 5-99953 ID: 4,6mm: 5-99959 ID: 5mm: 5-99954 ID: 5,3mm: 5-99960	9x16mm ID: 6mm: 5-99955	8x14mm ID: 4mm: 5-99931 ID: 4,3mm: 5-99936 ID: 4,6mm: 5-99935 ID: 5mm: 5-99930 ID: 5,3mm: 5-99934
			
		11,5x20mm ID: 6mm: 5-99958	

CLICKVERSCHLUSS VERSTELLBAR

click lock adjustable

		
5-99990-060 AD: 7,5mm ID: 6,0mm	5-99990-050 AD: 6,5mm ID: 5,0mm	5-99990-040 AD: 5,5mm ID: 4,0mm

KLAPPSCHLIESSE

click lock



5-99904
14,5 x 44 mm

KLAPPSCHLIESSE

fold-over clasp



5-99905
14,5 x 24,3 mm

CLICKVERSCHLUSS

click lock

						
5-99989-040 ID: 4 x 4mm AD: 5,5 x 5,5mm	5-99989-060 ID: 6 x 3mm AD: 7,9 x 4,9mm	5-99989-066 ID: 6,6 x 4mm AD: 7,9 x 4,9mm	5-99989-080 ID: 8 x 4mm AD: 9,9 x 5,9mm	5-99989-082 ID: 8,2 x 3mm AD: 9,9 x 4,9mm	5-99989-092 ID: 9,2 x 4,5mm AD: 11,1 x 6,1mm	5-99989-102 ID: 10,2 x 3mm AD: 11,9 x 4,9mm

Alle Angaben ohne Gewähr. Änderungen vorbehalten. Abbildungen und Fotos entsprechen nicht exakt der Originalgröße. Technische sowie Farbänderungen vorbehalten. Alle Artikel sind in verschiedenen Legierungen erhältlich. Es gelten unsere Allgemeinen Geschäftsbedingungen.

All statements without guarantee. Subject to change. Illustrations and photos do not exactly correspond to the original size. Technical and color changes reserved. All articles are available in different alloys. Our general terms and conditions apply.

CLICKVERSCHLUSS

click lock

			
5-99903-030 ID: 3 mm, AD: 4,9 mm	5-99903-033 ID: 3,3 mm, AD: 4,9 mm	5-99903-041 ID: 4,1 mm, AD: 5,9 mm	5-99903-050 ID: 5 mm, AD: 6,4 mm

		
5-99903-061 ID: 6,1 mm, AD: 7,9 mm	5-99903-076 ID: 7,6 mm, AD: 9,4 mm	5-99903-080 ID: 8 mm, AD: 9,9 mm

CZ VERSCHLUSS

cz clasps



					
5-99906-011 ID: 1,1 mm, L: 16,2 mm	5-99906-013 ID: 1,3 mm, L: 16,1 mm	5-99906-015 ID: 1,5 mm, L: 16,2 mm	5-99906-018 ID: 1,8 mm, L: 16,4 mm	5-99906-023 ID: 2,3 mm, L: 16,5 mm	5-99906-026 ID: 2,6 mm, L: 16,3 mm

BAYONETTEVERSCHLUSS

bayonette clasps





Seite 25
page 25

KNICK VERSCHLUSS

kink clasp



	
5-99901 L: 24,5 mm, D: 3 mm, 2-teilig	5-99900 L: 24,5 mm, D: 4 mm, 2-teilig

KAPSELN GERADE

caps

OHRMÜTTERN + STIFT

earnuts + pin

BRISUREN

lever backs

OHRHAKEN

earwire

						
7-40216 ID: 1,6 mm	7-40222 ID: 2,2 mm	5-00032 6 mm	5-00130-914 10mm, 2 Rillen D: 0,88 mm	5-01130	5-01050	5-00303 D: 0,8 mm

OHRSTECKER

ear studs







							
5-15225 2,5 mm	5-15230 3 mm	5-15240 4 mm	5-15250 5 mm	5-15280 8 mm	5-11830 3 mm	5-11840 4 mm	5-11850 5 mm

STEMPELPLÄTTCHEN

id tag

ÖSEN

loops

						
5-53010-925 10mm, 1 Loch	5-53010-926 10 mm, 2 Loch	5-53003 7,2 mm, 2 Loch	5-53000 5 x 3,6 mm	9-00037 20 x 10 mm	siehe Seite 26	5-23696 7,6 mm

KUGELN

balls

									
5-45615 1,5 mm Loch: 0,8 mm	5-45620 2 mm Loch: 0,8 mm	5-45625 2,5 mm Loch: 1 mm	5-45630 3 mm Loch: 1,2 mm	5-45635 3,5 mm Loch: 1,2 mm	5-45640 4 mm Loch: 1,2 mm	5-45645 4,5 mm Loch: 1,2 mm	5-45650 5 mm Loch: 1,2 mm	5-45660 6 mm Loch: 1,2 mm	5-45670 7 mm Loch: 1,2 mm





Alle Angaben ohne Gewähr. Änderungen vorbehalten. Abbildungen und Fotos entsprechen nicht exakt der Originalgröße. Technische sowie Farbänderungen vorbehalten. Alle Artikel sind in verschiedenen Legierungen erhältlich. Es gelten unsere Allgemeinen Geschäftsbedingungen.



All statements without guarantee. Subject to change. Illustrations and photos do not exactly correspond to the original size. Technical and color changes reserved. All articles are available in different alloys. Our general terms and conditions apply.

WECHSELMECHANIK





interchangeable system

 auch in Gold erhältlich / Seite 24
available in gold / page 24

							
5-26320 Schaft: 3,0 mm Bohrung: 2,0 mm	5-26325 Schaft: 3,0 mm Bohrung: 2,5 mm	5-26335 Schaft: 3,5 mm Bohrung: 3,0 mm	5-26337 Schaft: 3,7 mm Bohrung: 3,2 mm	5-26345 Schaft: 4,5 mm Bohrung: 4,0 mm	5-26348 Schaft: 4,8 mm Bohrung: 4,3 mm	5-26355 Schaft: 5,5 mm Bohrung: 5,0 mm	5-26358 Schaft: 5,8 mm Bohrung: 5,3 mm

		
5-26365 Schaft: 6,5 mm Bohrung: 6,0 mm	5-26385 Schaft: 8,5 mm Bohrung: 7,6 mm	5-26390 Schaft: 9,0 mm Bohrung: 8,2 mm

				
5-26301 Schaft: 2,6 mm Bohrung: 1,5 mm L: 1 mm zum anlöten	5-26302 Schaft: 3 mm Bohrung: 1,15 mm L: 0,8 mm	5-26300 Schaft: 2,6 mm Bohrung: 1,5 mm L: 1 mm zum Fädeln	5-26304 Schaft: 3,5 mm Bohrung: 1,45 mm L: 1 mm	5-26318 Schaft: 3,5 mm Bohrung: 1,8 mm L: 1,1 mm

				
5-26306 4 x 7,7 mm	5-26307 7,8 x 11,1 mm mit Linse	5-26400 3,4 x 5 mm mit Rand, montiert	5-26403 3,4 x 6 mm ohne Rand, montiert	5-26410 3,4 mm L: 7-20 mm, montiert



9-99800
2-component glue



9-99801
superglue

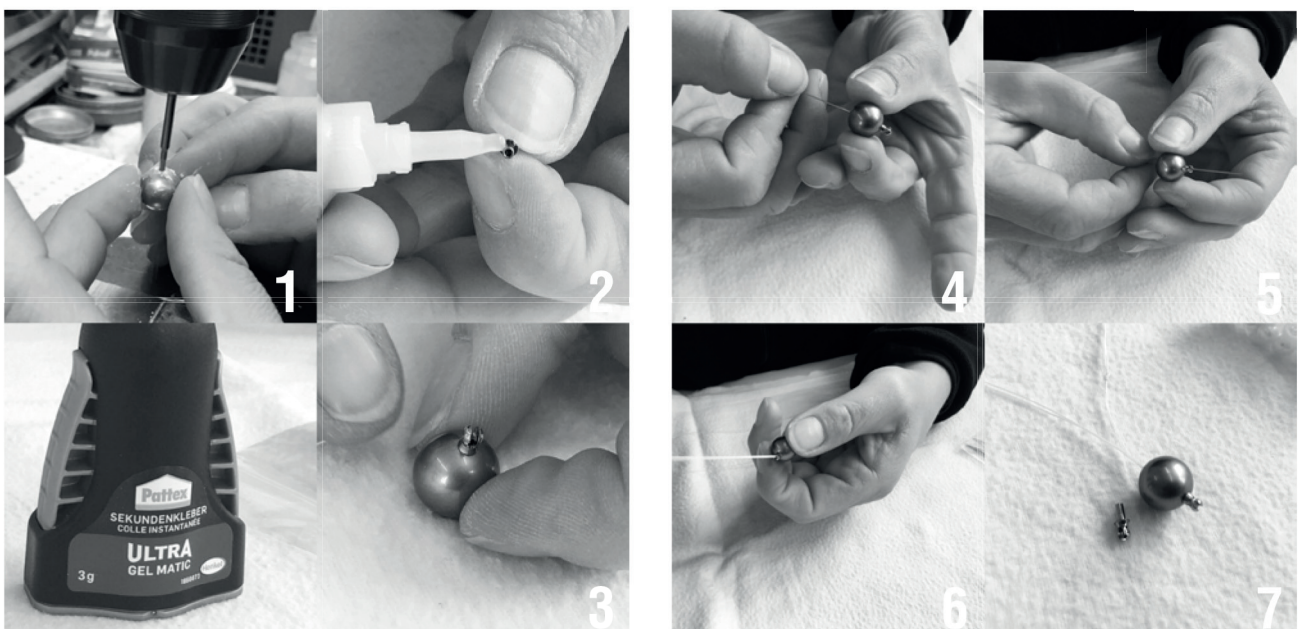

SCHLIESSEN MIT WECHSELMECHANIK

interchangeable system



				
5-W7080 Kugel 8mm	5-W7100 Kugel 10mm	5-W7120 Kugel 12mm	5-W7140 Kugel 14mm	5-W7160 Kugel 16mm
				
5-W7180 Kugel 18mm	5-W7200 Kugel 20mm	5-W7300 Olive 11,5x15mm	5-W7220 Zylinder 12x18mm	5-W7210 Zylinder 10x15mm
				
5-W7260 Zylinder 14x12mm	5-W7270 Zylinder 14x18mm	5-W7230 Zylinder 10x12mm	5-W7240 Zylinder 12x16mm	5-W7250 Fass 12x9mm
				
5-W7280 Fass 14x10,5mm	5-W7290 Fass 16x12mm	5-W7350 Bone 16x12mm	5-W7340 Bone 14x10,5mm	5-W7320 Tonne 14x12mm

STAINLESS STEEL

Alle Angaben ohne Gewähr. Änderungen vorbehalten. Abbildungen und Fotos entsprechen nicht exakt der Originalgröße. Technische sowie Farbänderungen vorbehalten. Alle Artikel sind in verschiedenen Legierungen erhältlich. Es gelten unsere Allgemeinen Geschäftsbedingungen.

All statements without guarantee. Subject to change. Illustrations and photos do not exactly correspond to the original size. Technical and color changes reserved. All articles are available in different alloys. Our general terms and conditions apply.



5-W7050 | Zylinder
5 x 9 mm

SCHLIESSEN MIT WECHSELMECHANIK | ZIRKONIA RUNDUM

interchangeable system zirconia around

5-W710R Kugel 10mm, 8 Zirkonia	5-W712R Kugel 12mm, 10 Zirkonia	5-W714R Kugel 14mm, 12 Zirkonia	5-W716R Kugel 16mm, 14 Zirkonia	5-W718R Kugel 18mm, 16 Zirkonia

5-W720R Kugel 20mm, 18 Zirkonia	5-W722R Zylinder 12x18mm, 8 Zirkonia	5-W721R Zylinder 10x15mm, 8 Zirkonia	5-W726R Zylinder 14x12mm, 8 Zirkonia	5-W727R Zylinder 14x18mm, 8 Zirkonia

5-W723R Zylinder 10x12mm, 8 Zirkonia	5-W724R Zylinder 12x16mm, 8 Zirkonia	5-W729R Fass 16x12mm, 8 Zirkonia	5-W728R Fass 14x10,5mm, 8 Zirkonia	5-W725R Fass 12x9mm, 8 Zirkonia

5-W735R Bone 16x12mm, 8 Zirkonia	5-W734R Bone 14x10,5mm, 8 Zirkonia	5-W733R Tonne 14x12mm, 10 Zirkonia	5-W730R Olive 11,5x15mm, 8 Zirkonia

SCHLIESSEN MIT WECHSELMECHANIK | ZIRKONIA GESTREUT

interchangeable system zirconia sprinkle

				
5-W710CZ Kugel 10mm, 7 Zirkonia	5-W712CZ Kugel 12mm, 8 Zirkonia	5-W714CZ Kugel 14mm, 10 Zirkonia	5-W716CZ Kugel 16mm, 12 Zirkonia	5-W718CZ Kugel 18mm, 12 Zirkonia
				
5-W720CZ Kugel 20mm, 12 Zirkonia	5-W732CZ Tonne 14x12mm, 8 Zirkonia	5-W731CZ Olive 11,5x15mm, 8 Zirkonia		

STAINLESS STEEL

*NEW *interchangeable system with zirconia sprinkle*







			
5-W752Z 12mm	5-W754Z 14mm	5-W756Z 16mm	5-W758Z 18mm



5-W7500-R | red
5-W7500-S | black
5-W7500-G | yellow
5-W7500 | white





Alle Angaben ohne Gewähr. Änderungen vorbehalten. Abbildungen und Fotos entsprechen nicht exakt der Originalgröße. Technische sowie Farbänderungen vorbehalten. Alle Artikel sind in verschiedenen Legierungen erhältlich. Es gelten unsere Allgemeinen Geschäftsbedingungen.

All statements without guarantee. Subject to change. Illustrations and photos do not exactly correspond to the original size. Technical and color changes reserved. All articles are available in different alloys. Our general terms and conditions apply.



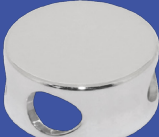

KETTENSTOPPER <i>PUSH BUTTON</i>	Artikel Nr. <i>Ref. No.</i>	Maß <i>size</i>	Ø mm	Legierung <i>alloy</i>
	9-00050	4,0x1,2		● ●
	9-00051	4,5x1,5		● ●
	9-00052	5,0x1,9		● ●
	9-00053	5,5x2,3		● ●
	9-00054	6,0x2,8		● ●

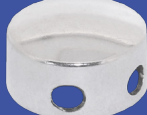
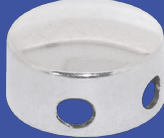

● Silber *silver* ● Gold *gold* ● Edelstahl *stainless steel*

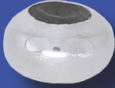
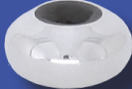
KETTENSTOPPER flach/gewölbt <i>SLIDERS flat/curved</i>	Artikel Nr. Ref. No.	Maß size Ø mm	Legierung alloy
	9-00048	6,8x3,6	● ● ●
	9-00044	8,0x4,5	● ● ●
	9-00056	9,5x5,0	●
	9-00055	6,8x4,2	● ●
	9-00058	8,0x7,0	●
	9-00057	9,5x8,4	●



STOPPER MIT SILIKON <i>STOPPER WITH SILICONE</i>	Artikel Nr. <i>Ref. No.</i>	Maß <i>size</i> Ø mm	Legierung <i>alloy</i>
	9-00088	5/2,5	● ●
	9-00089	6/3,2	● ●
	9-00090	5/2,2	● ●
	9-00091	6/2,4	● ●
	9-00092	8/4,5	● ●
	9-00093	10/4,2	● ●

